



**CIEL LIGHT CO.,LTD.**

**PRODUCT SPECIFICATION**

Model No.: CLD-3621BUR-11

Drawing No.: \_\_\_\_\_

Customer: \_\_\_\_\_

Customer's Model No.: \_\_\_\_\_

Customer's Drawing No.: \_\_\_\_\_

Descriptions

1. Emitting color: Ultra Red
2. Lens color: White Diffuse
3. Surface black color :Black
4. Dice material: AlGaInP

Outline drawing

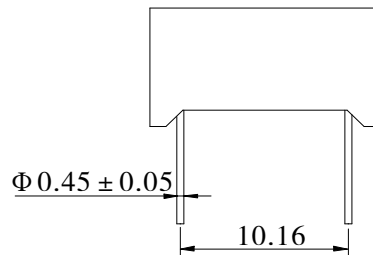
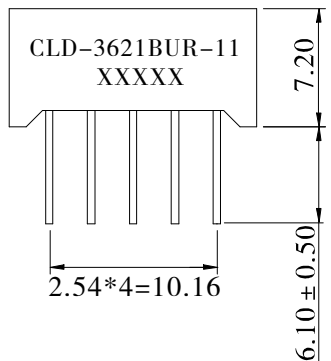
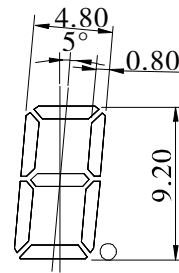
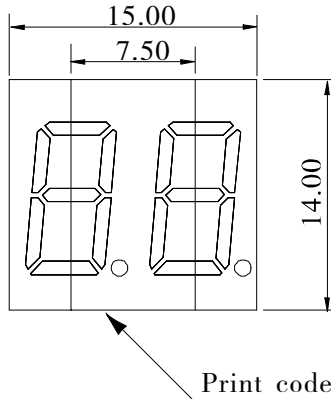

Tolerance is ± 0.25mm unless otherwise noted  
PIN Bending ≤ Length \* 1%

Internal Circuit Diagram (C.A.)

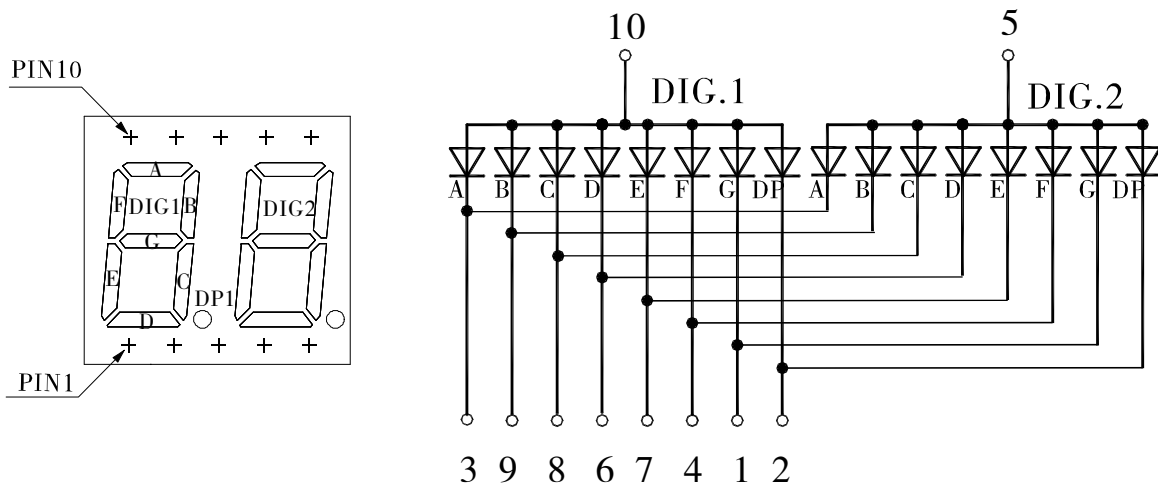

Electrical optical characteristics ( Ta=25°C )

Parameter	Symbol	Ultra Red			Unit	Test Condition
		Min	Typ	Max		
Forward Voltage	V <sub>F</sub>	---	2.0	2.2	V	IF=20mA
Luminous Intensity	I <sub>V</sub>	2.8	4.0	---	mcd	IF=20mA
Peak Wavelength	λ <sub>P</sub>	---	645	---	nm	IF=20mA
Dominant Wavelength	λ <sub>d</sub>	---	639	---	nm	IF=20mA
Spectral Line half-width	Δλ	---	20	---	nm	IF=20mA
Reverse Leakage Current	I <sub>R</sub>	---	---	50	μA	V <sub>R</sub> =5V

Absolute maximum parameters ( Ta=25°C )

Parameter	Symbol	Condition	Rating	Unit
Power Dissipation	PD	---	80	mW
Reverse Voltage	VR	---	5	V
Forward Average Current	IF	---	30	mA
Temperature coefficient	I/C	---	0.33	mA/°C
Pulse Current	IFP	Duty=1/10,1kHz	100	mA
Operating Temperature Range	Topr	---	-25 ~ +85	°C
Storage Temperature Range	Tstg	---	-30 ~ +100	°C
Soldering Condition	Tsd	---	260/5sec	°C

Typical Electro-Optical characteristic curves ( Ta=25°C )

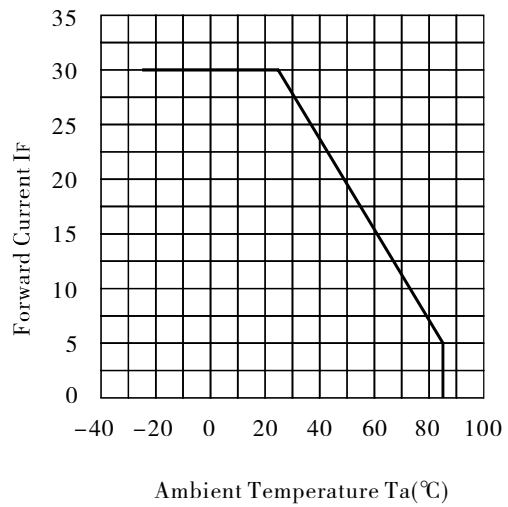
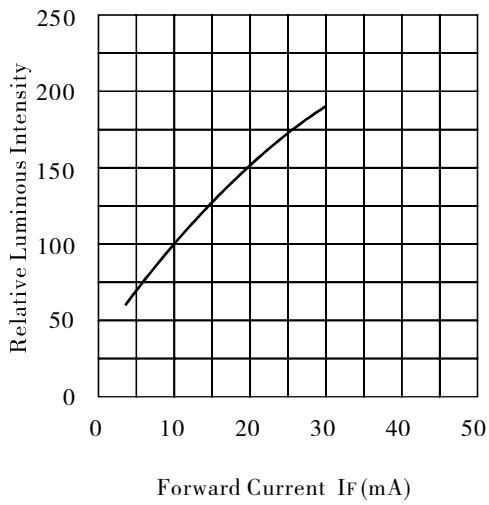
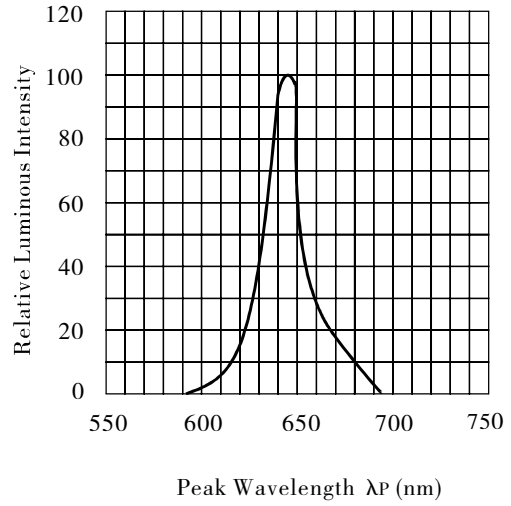
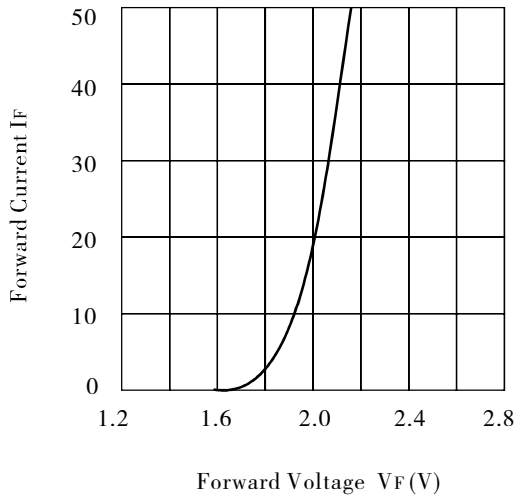

Reliability test conditions

Test Item	Test Condition	Result	Judgment criteria
Consecutive operating life test	IF=20mA, T=25°C, t=168h	0/12	Forward Voltage $V_F(V) = \text{Upper Limit} \times 1.2$ Reverse Leakage Current $I_R(\mu A) = \text{Upper Limit} \times 2.0$ Luminous Intensity $I_v$ (mcd) = Lower Limit $\times 0.7$
High temperature storage life test	T=100°C, t=168h	0/12	
Low temperature storage life test	T=-25°C, t=168h	0/12	
high Temperature humidity storage life test	T=85 ± 2°C, RH=85% ± 3, t=168h	0/12	
Temperature cycle test	-25°C~25°C~100°C, 30min 5min 30min 10cycles	0/12	
Thermal shock test	100°C 0°C 5min 5min 20 cycles	0/12	
Soldering heat test	T=260 ± 5°C, t=10s ± 1s	0/12	
Solderability test	T=230 ± 5°C, t=5s ± 0.5s	0/12	Steeped Part ≥ 95%
Fall test	h=100cm, Free fall, 3times	0/12	Intact
Terminal strength test	W=9.8N, t=30 ± 5s	0/12	
Lead Bending test	W=4.9N, 2times	0/12	