

## CL-5043URC1E-001

### Features:

- High intensity
- General purpose leads
- RoHs complant.

### Descriptions:

- Dice material: AlGaInP
- Emitting Color: Super bright Red
- Device Outline:  $\Phi$ 5mm Cylinder Type.
- Lens Type: water clear.

### Radiation pattern.

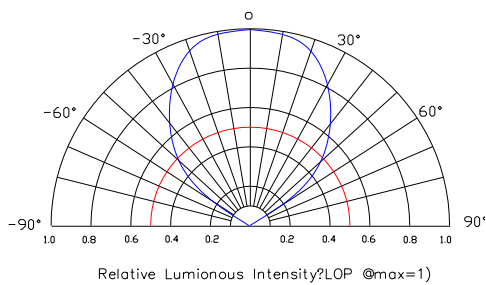

### Package configuration

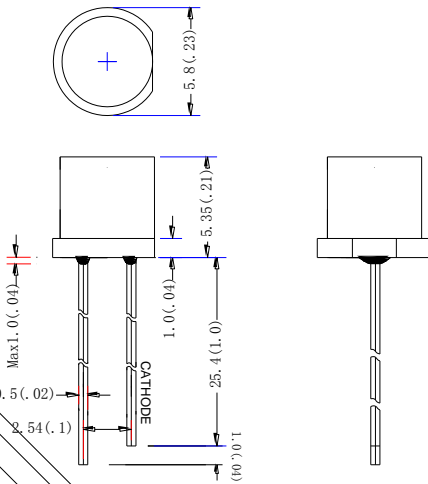

- ◆ All dimensions are millimeters (inches)
- ◆ Tolerance is  $\pm 0.25\text{mm}(.010")$  unless otherwise noted.

### Absolute maximum ratings( $T_a=25^\circ\text{C}$ )

Parameter	MAX.	Unit
Power Dissipation	50	mW
Peak Forward Current (1/10 Duty Cycle, 0.1ms Pulse)	100	mA
Continuous Forward Current	20	mA
Derating Linear From $50^\circ\text{C}$	0.4	mA/ $^\circ\text{C}$
Reverse Voltage	5	V
Operating Temperature Range	$-30^\circ\text{C}$ to $+80^\circ\text{C}$	
Storage Temperature Range	$-40^\circ\text{C}$ to $+100^\circ\text{C}$	
Lead Soldering Temperature[4mm(.157") From Body]	260 $^\circ\text{C}$ for 5 Seconds	

### Electrical and optical characteristics( $T_a=25^\circ\text{C}$ )

Parameter	Symbol	Min.	Typ.	Max.	Unit	Test Condition
Luminous Intensity	IV	-	460	-	mcd	IF=20mA
Viewing Angle	2 $\theta$ 1/2	90	100	110	Deg	
Peak Emission	$\lambda_p$	625	630	635	nm	
Dominant Wavelength	$\lambda_d$	620	625	630	nm	
Spectral Line Half-Width	$\Delta\lambda$	10	15	20	nm	
Forward Voltage	VF	1.8	2.1	2.3	V	
Reverse Current	IR			10	$\mu\text{A}$	VR=5V

# LED LAMP

## Typical Electrical Characteristics Curves (25 °c Ambient Temperature Unless Otherwise Noted)

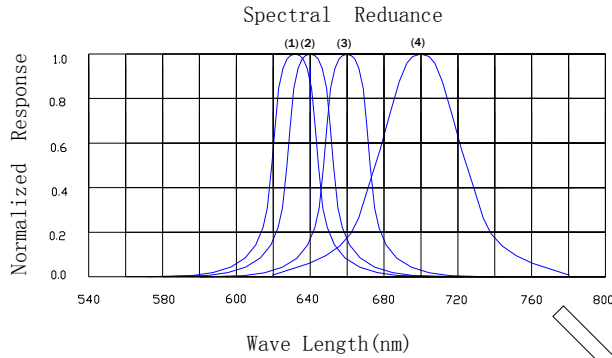

- (1) AlGaInP peak@630/Red
- (2) GaAsP/GaP peak@640nm /Red
- (3) AlGaAs/GaAs peak@660nm/Super Red
- (4) GaP peak@700nm/ Red

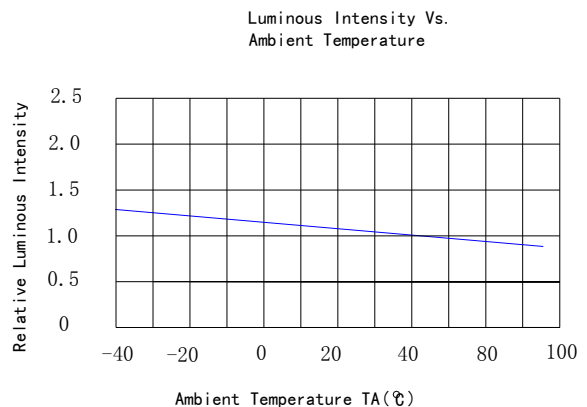
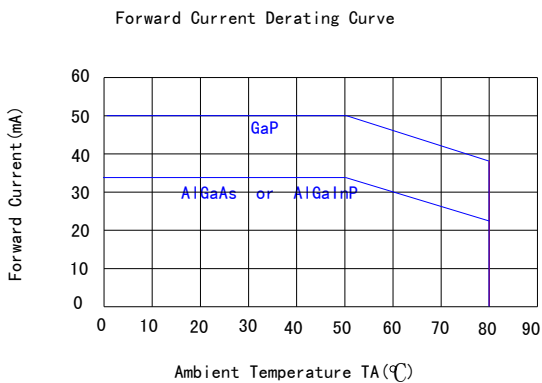
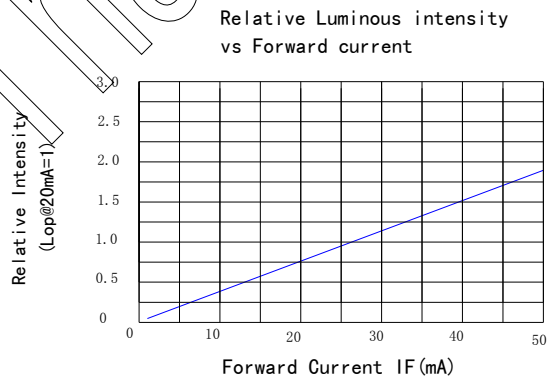
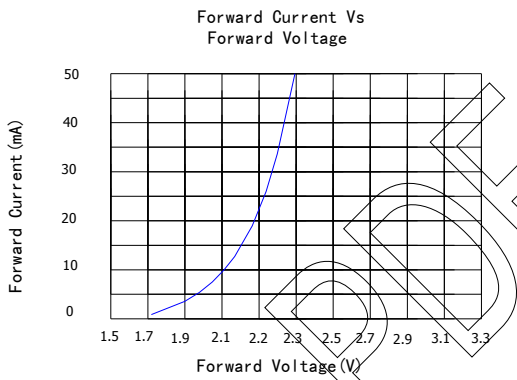

# LED LAMP

## LAMP PACKING.

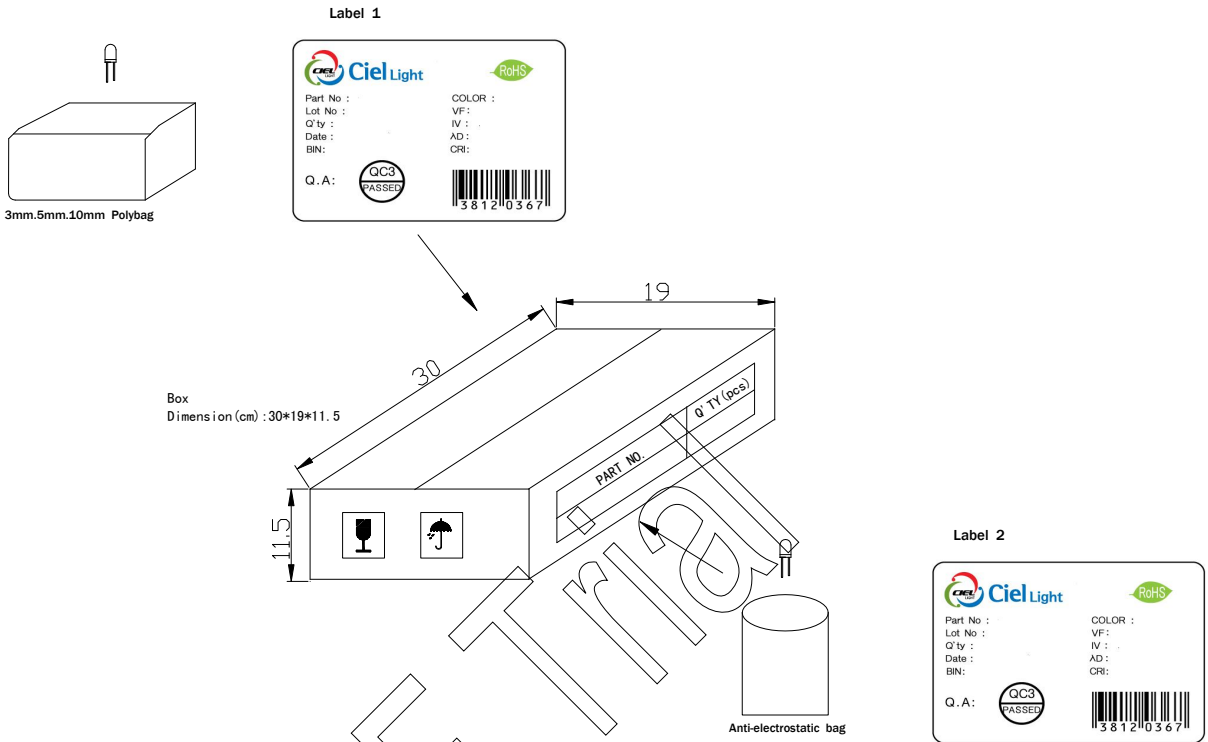

DEVICE	QTY/polybag(pcs)	Polybag/box A	Fig
5mm(T-1 3/4)	1000	8 bags	Label 1
3mm(T-1)	1000	10 bags	Label 1
10mm(T-1)	250	8 bags	Label 1
Blue/Green/White	500	8 bags	Label 2

**CARTON**  
Dimension(cm):39\*32\*38

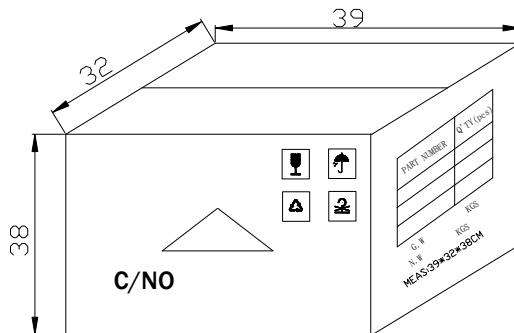

**6 Boxes/Carton**  
**5mm:48,000pcs**  
**3mm:60,000pcs**  
**10mm:12,000pcs**  
**Blue/Pure Green/bluish Green**  
**/White:24,000pcs**