

Data Sheet

Customer: _____
Part No: _____ SFC506DLG-01 _____
Sample No: _____
Description: _____ 5050 Green SMD _____
Item No: _____

Customer			
Check	Inspection	Approval	Date

Features:

- . Reflow Solderable
- . High Luminous Intensity and Low Power Dissipation
- . Good Reliability and Long Life
- . Complied With RoHS Directive

Technical Data Sheet

This product is generally used as indicator and luminary for electronic equipment such as household appliance, communication equipment, and dashboard.

Applications

- Optical indicator
- Indoor display
- Backlighting in dashboard and switch
- Flat backlighting for LCD, symbol and display
- General use

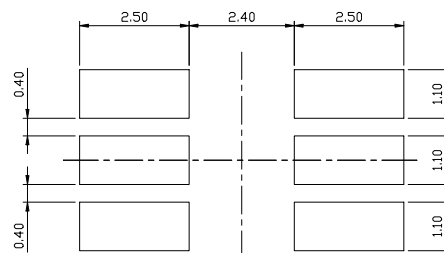
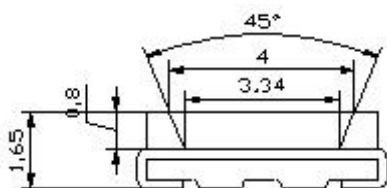
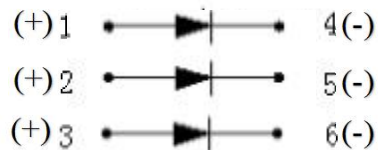
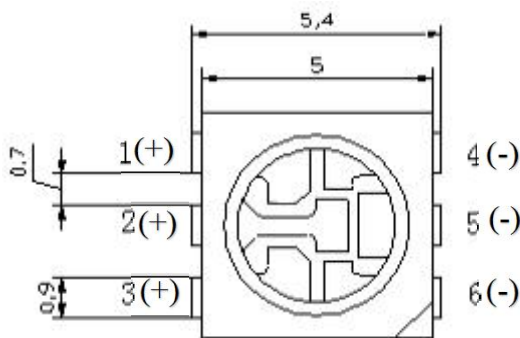

Notes:

- 1 . All dimension units are millimeters.
2. All dimension tolerance is ± 0.2 mm unless otherwise noted.

Selection Guide

Part No.	Dice	Lens Type	Luminous intensity(mcd) @ 60mA			Viewing Angle
			Min	Typ	Max	
SFC506DLG-01	Green (InGaN)	Water Clear	2200	--	4900	120

Note:

1. 1/2 is the angle from optical centerline where the luminous intensity is 1/2 the optical centerline value.

2. the above luminous intensity measurement allowance tolerance $\pm 10\%$

2.30LM above Products lumens allow differences: $\pm 1LM$

Electrical / Optical Characteristics at Ta=25°C

Parameter	Symbol	Min.	Typ.	Max	Units	test conditions
Forward Voltage	VF	2.8	--	3.4	V	IF=60mA
Reverse Current	IR	--	--	10	uA	VR = 5V
Dominate Wavelength	λ_d	515	--	524	nm	IF=60mA

Absolute Maximum Ratings at Ta=25°C

Parameter	Symbol	Rating	Units
Power Dissipation	Pd	200	mW
DC Forward Current	IF	60	mA
Peak Forward Current [1]	IFP	120	mA
Reverse Voltage	VR	5	V
Operating Temperature	Topr	-40~+85	°C
Storage Temperature	Tstg	-40~+100	°C

Note:

1. 1/10 Dut cycle, 0.1ms pulse width.

2. The above forward voltage measure ment allowance tolerance $\pm 0.1V$.

3. The tolerance of wave length: $\pm 1nm$.

Typical optical characteristics curves

Ambient Temperature VS. Forward Current

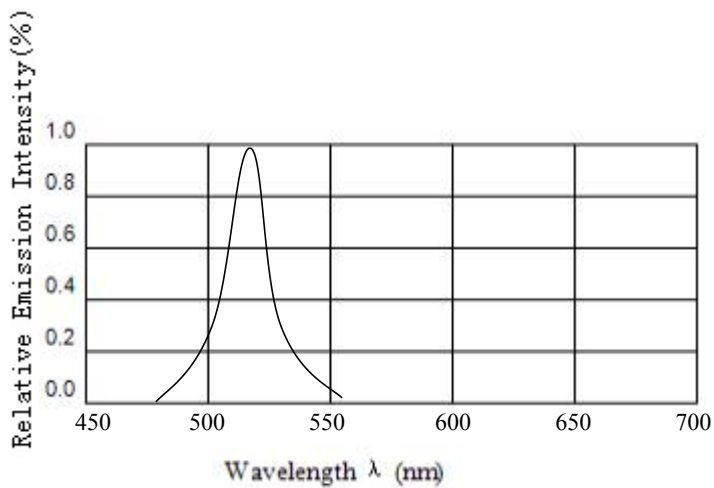
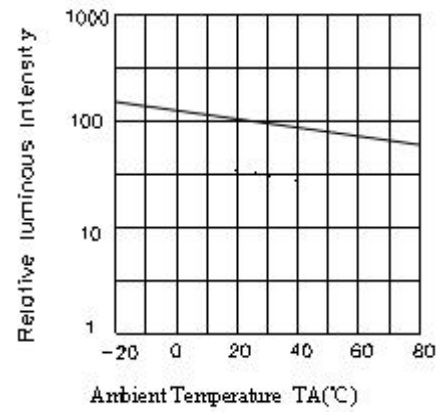
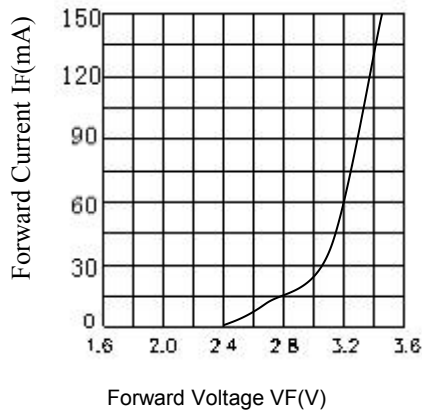
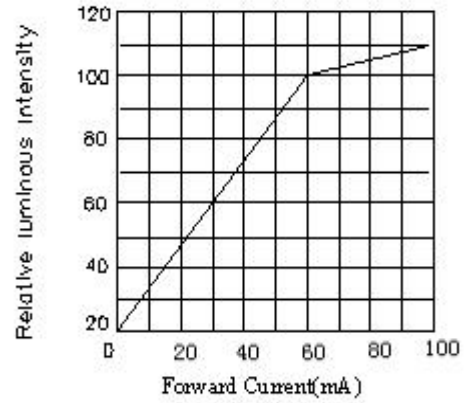
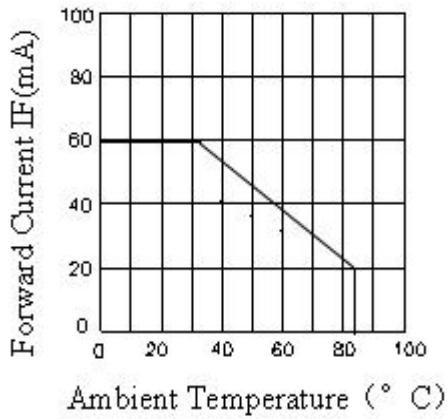
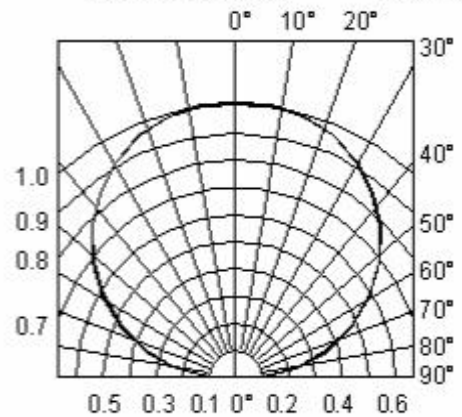
 Radiation Diagram $T_a=25^\circ\text{C}$

Reliability Test Items And Conditions

The reliability of products shall be satisfied with items listed below.

Confidence level :90%

LTPD :10%

Test Items	Test conditions	Quantity	Judging Criteria
Solderability	Solder Temperature: 240°C Solder Duration: (3.5±0.5) sec.	22	Solderable Area Over 95%
Thermal Shock Followed by High Temperature And High Humidity Cyclic	-40° → 10min 5 Cycles ↑ ↓ shift(2~3)min 100°C → 10 min. ☰ 25°C~55°C (90%~95%) RH 2 Cycles for 48 hrs., Recover for 2 hrs	22	C=0 & I**
Resistance For Soldering Heat	Reflow Soldering	22	C=0 & I**
DC Operating Life	1000 hrs. Forward Current: 60mA	22	C=0 & I**
High Temperature Storage	100°C ☐ → 1000 hrs	22	C=0 & I**
High Temperature And High Humidity Cyclic	25°C~55°C (90%~95%) RH 6 Cycles for 144 hrs., Recover for 2 hrs.	22	C=0 & I**

The technical information shown in the data sheets are limited to the typical characteristics and circuit examples of the referenced products. It does not constitute the warranting of industrial property nor the granting of any license.

SMT Reflow Soldering Instructions

1. Reflow soldering should not exceed once.
2. In soldering process, do not stress on the LEDs during heating.

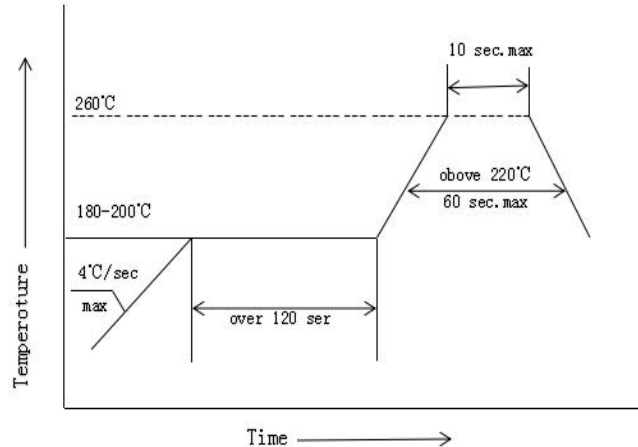

Soldering iron

1. When hand soldering, the temperature of the iron must be lower than 300°C for 3 seconds.
2. The hand solder should be done only one time.

Repairing

Repair should not be done after the LEDs have been soldered. When repairing is unavoidable, a double-head soldering iron should be used (as below figure). It should be confirmed beforehand whether the characteristics of LEDs will or will not be damaged by repairing.

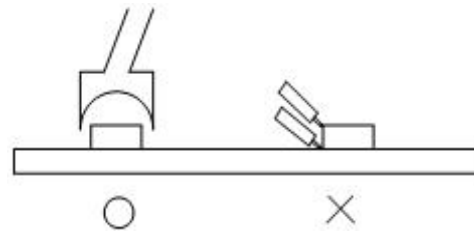

Storage

The package is sealed:

1. Recommended storage condition: At 5°C~30°C and relative humidity 90% RH max.
2. It is recommended that SMD out of their original packaging are used within one year.

The package is opened:

1. Completed within 24 hours.
2. Stored at 5°C~30°C and 60% RH or less.
3. LEDs stored more than 24 hours should be baked at about 60°C±5°C for at least 20 hours before solder assembly.

Handling Precautions

1. Do not stack together assembled PCBs containing LEDs. Impact may scratch the silicone lens or damage.

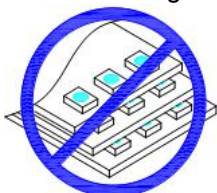

2. Not available in the situation of acidity for PH.



Packaging

Carrier tape (MPQ:1000PCS/reel)

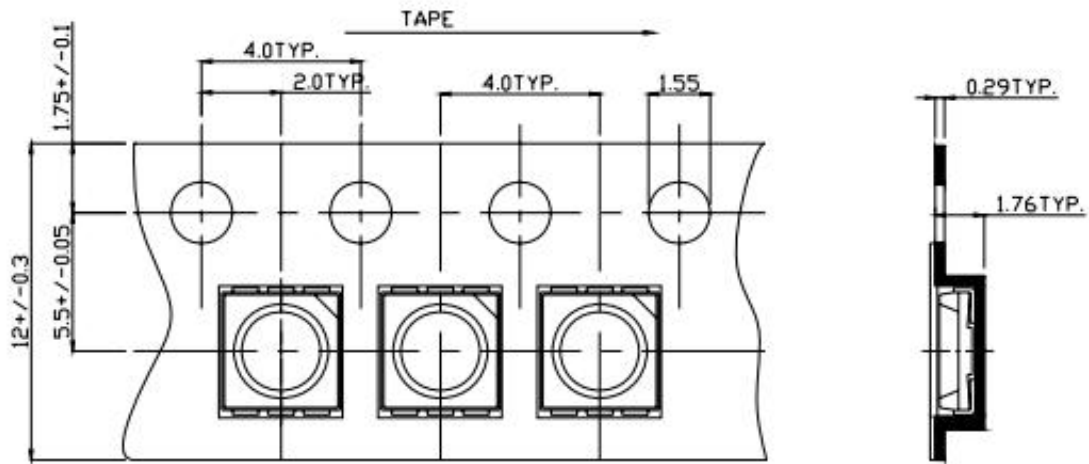
 Note: The tolerances unless mentioned is ± 0.1 mm, Unit: mm

Moisture Resistant Packaging
