

**Surface Mounted Chip LED**
**Model No. : CL-SP110UHR**
**■ Features :**

- Compatible with automatic placement equipment
- Compatible with reflow solder process

**■ Applications :**

- Automotive\_Telecommunication
- Indicators
- LCD Back-lights
- Illuminations

Dice Material	Light Color	Lens Color
AlGaInP	Ultra High Red	Water Clear

**Absolute Maximum Ratings**
**( Ta=25°C )**

Item	Symbol	Maximum	Unit
Power Dissipation	P <sub>D</sub>	78	mW
Continuous Forward Current	I <sub>F</sub>	30	mA
Peak Forward Current (1/10 Duty Cycle 0.1ms Pulse Width)	I <sub>FP</sub>	100	mA
Reverse Voltage	V <sub>R</sub>	5	V
Derating Linear From 25°C		0.4	mA/°C
Operating Temperature Range	T <sub>opr</sub>	-30 to +80	°C
Storage Temperature Range	T <sub>stg</sub>	-40 to +85	°C

**Electrical / Optical Characteristics**
**( Ta=25°C )**

Item	Symbol	Condition	Min.	Typ.	Max.	Unit
Forward Voltage	V <sub>F</sub>	IF=20mA		2.1	2.6	V
Reverse Current	I <sub>R</sub>	VR=5V			10	uA
Peak Emission Wavelength	λ <sub>P</sub>	IF=20mA		645		nm
Dominant Wavelength	λ <sub>D</sub>	IF=20mA		631		nm
Viewing Angle	2θ <sub>1/2</sub>	IF=20mA		110		Deg
Luminous Intensity	I <sub>V</sub>	IF=20mA	30	60		mcd

ISSUE	DIMENSION NO :	VERSION :	DATE :
		C	2007/02/01
	APPROVAL :	CHECK :	EDIT :

◆ Packing coding principle

Notice: Bin code: luminous intensity / wavelength .

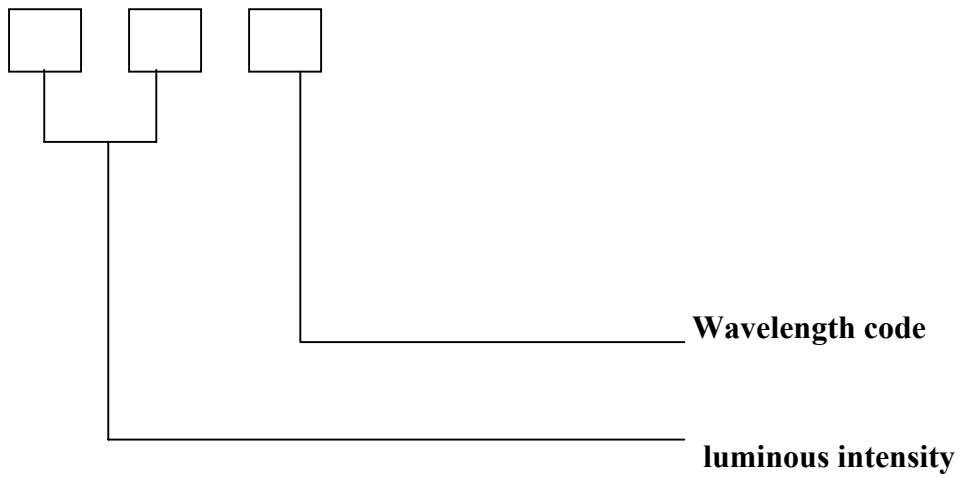

◆ The Luminous Intensity Grade of Ultra High Red Chip-LED Products

● Test Condition : @ 20mA

Range,mcd	Bin code
72/90	K1
90/115	K2
115/145	L1
145/180	L2

Dominant Wavelength Grade of Ultra High Red Chip-LED Products

● I type @ 20mA

BIN	Range
1	623/627
	627/640

◆ **Descriptions :**

- The Chip-LED Taping is much smaller than lead frame type components, thus enable smaller board size, higher packing density, reduced storage space and finally smaller equipment to be obtained.
- Besides, lightweight makes them ideal for miniature application, etc.

◆ **Reliability Test Items And Conditions :**

NO.	Item	Test Conditions	Test Hours / Cycle	Sample Q'ty	Ac / Re
1	Solder Heat	TEMP : 260°C±5°C	5 sec	36 pcs	0 / 1
2	Temperature Cycle	H : +100°C 30min. ∩ 5min. L : -40°C 30min.	50 cycle	36 pcs	0 / 1
3	Thermal Shock	H : +100°C 5min. ∩ 10sec L : -40°C 5min.	50 cycle	36 pcs	0 / 1
4	High Temperature Storage	TEMP : 100°C	1000 hrs	36 pcs	0 / 1
5	Low Temperature Storage	TEMP : -40°C	1000 hrs	36 pcs	0 / 1
6	DC Operating Life	I <sub>F</sub> = 20mA	1000 hrs	36 pcs	0 / 1
7	High Temperature / High Humidity	85°C / 90~95%R.H.	1000 hrs	36 pcs	0 / 1

◆ **Reflow Temp. / Time : :**

Please refer to the following figure :

Temp.(°C)		Time(Sec)	
a	25	T0~T1	Max. 3°C/sec
b	150	T1~T2	90~130 sec
c	200	T2~T3	Max. 3°C/sec
d	220	T3~T4	Max. 30~50 sec
e	250		
		T4~T5	Max. -3°C/sec
Blet Speed		70~90 cm/min	

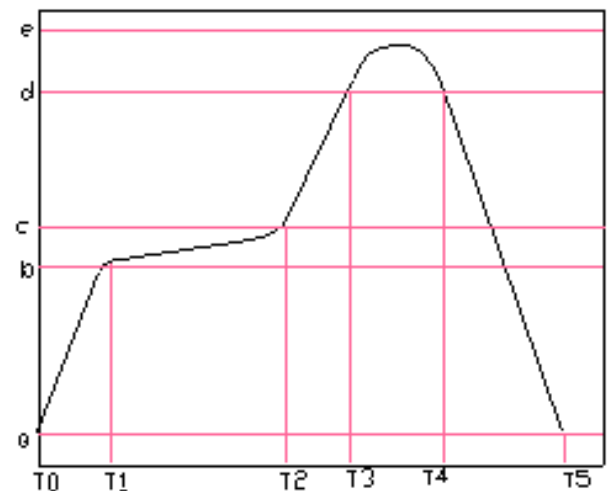

◆ **Precautions For Use :**

- Over - current - proof

Customer must apply resistors for protection, otherwise slight voltage shift will cause big current change ( Burn out will happen )

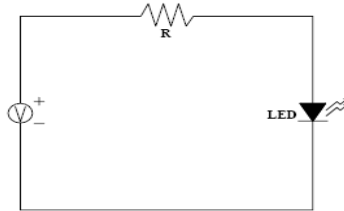

- Storage

1. The operation of temperature and R.H. are :  $5^{\circ}\text{C} \sim 30^{\circ}\text{C}$  , R.H.60% Max..
2. Once the package is opened, the products should be used within 72 hrs. Otherwise, they should be kept in a dampproof box with desiccating regent. Considering the tape life, we suggest our customers to use our products within 1 year ( from production date ) .
3. It's recommended to bake before soldering when the package is unsealed after 72 hrs. The condition is :  $80^{\circ}\text{C} \pm 5^{\circ}\text{C}$  for 24hrs.

◆ **Soldering Iron :**

- Temperature at tip of iron :  $300^{\circ}\text{C}$  Max. ( 25W Max. )
- Soldering time :  $5 \pm 1\text{sec}$ .

◆ **Wave Soldering Temp. / Time :**

Temp.( $^{\circ}\text{C}$ )		Time(Sec)	
a	25	T1~T2	$60 \pm 20$
b	$130 \pm 10$	T2~T3	
c	185	T3~T6	
d	$250 \pm 3$	T4~T5	$3 \pm 2$

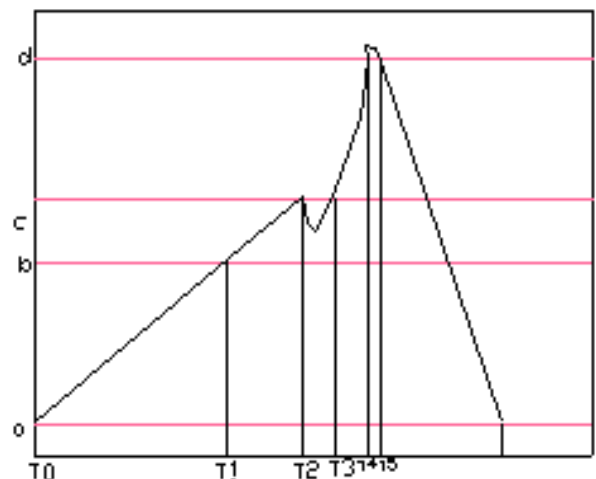

◆ Package Dimensions of Device

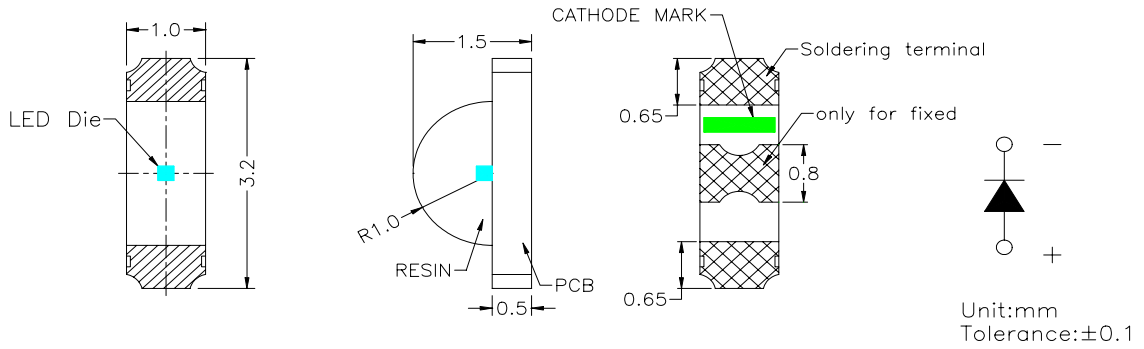

1. Soldering terminal may shift in x, y direction.
2. Polarity referring onto the cathode mark is reversed on the UR/HR/SR

◆ Recommended Soldering Pad Dimensions

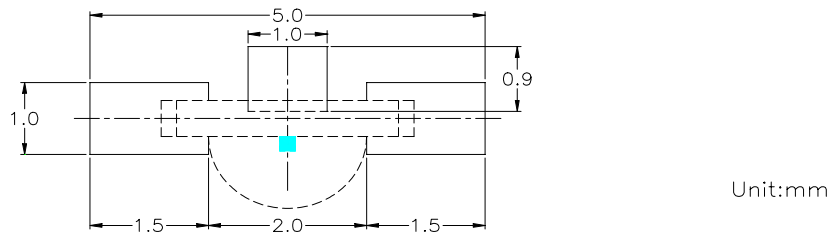

◆ Tape Specification : 3000pcs Per Reel

Packing Size													
Item	W	P1	E	F	Do	D1	Po	10Po	P2	Ao	Bo	Ko	t
Spec.	8.00	4.00	1.75	3.50	1.50	1.00	4.00	40.00	2.00	1.60	3.35	1.15	0.22
Tolerance	±0.20	±0.10	±0.10	±0.05	$^{+0.10}_{-0.00}$	±0.05	±0.05	±0.20	±0.05	±0.10	±0.10	±0.10	±0.05

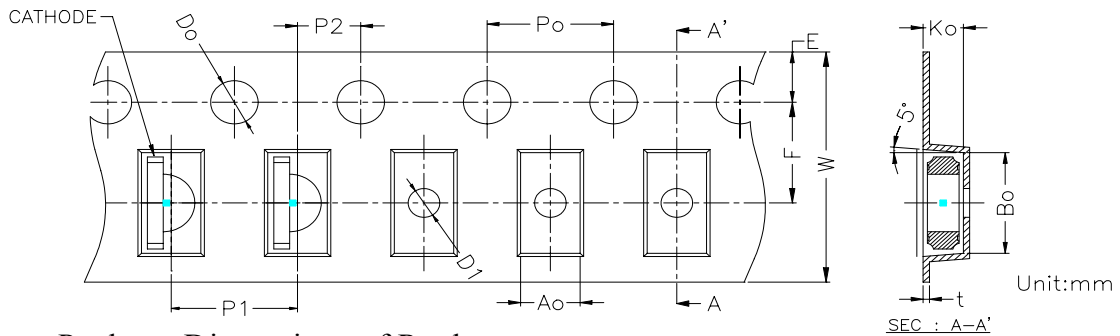

◆ Package Dimensions of Reel :

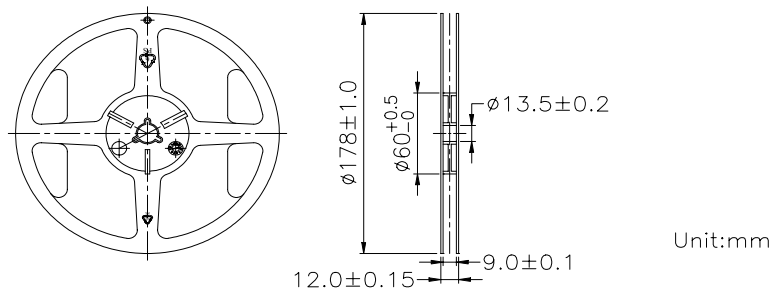

◆ Typical Electro-Optical Characteristic Curves: SP110 series

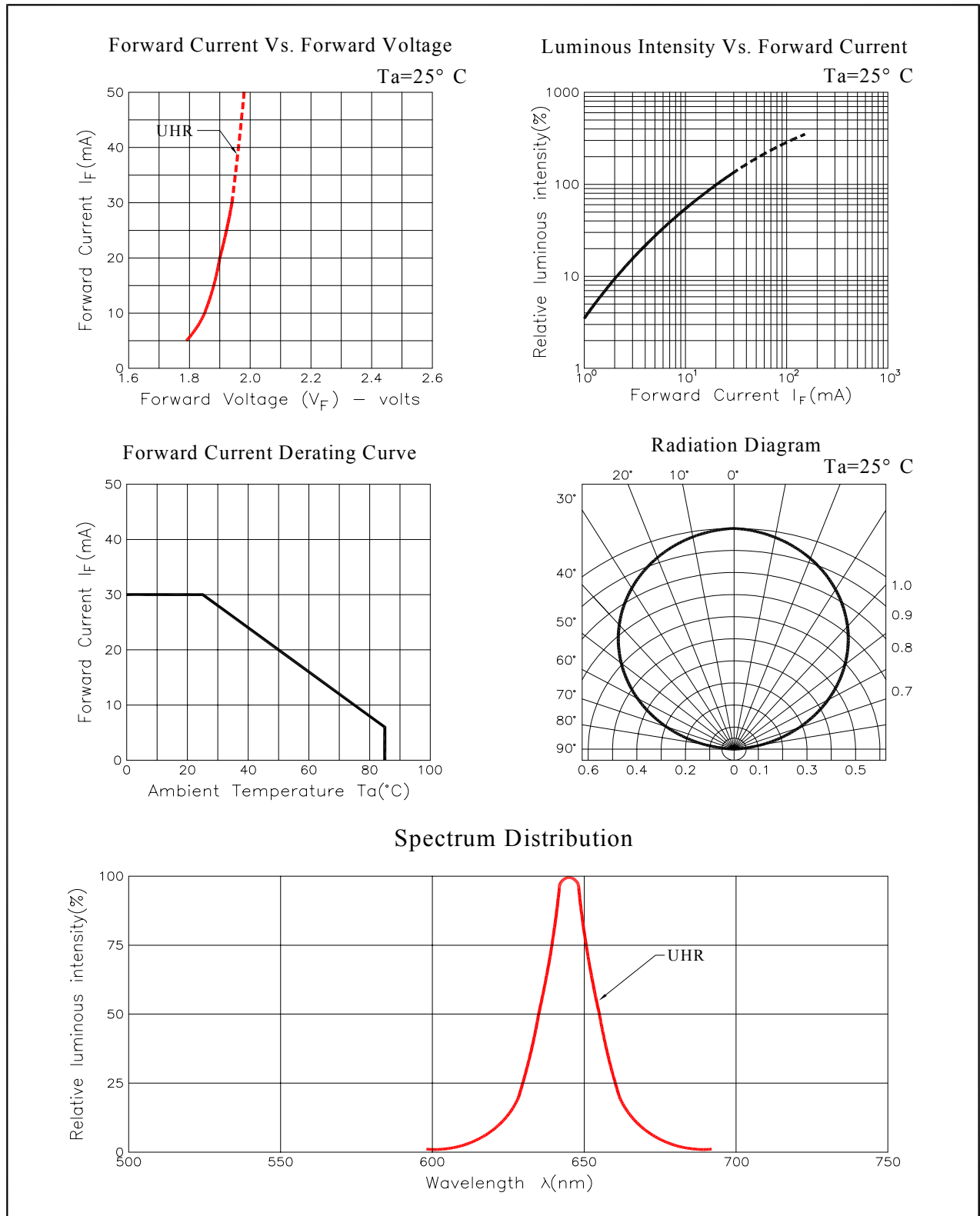

◆ Packing and Shipping Spec.

