

Surface Mounted Chip LED
Model No. : CLSP150UHY
■ Features :

- Compatible with automatic placement equipment
- Compatible with reflow solder process

■ Applications :

- Automotive_Telecommunication
- Indicators
- LCD Back-lights
- Illuminations

Dice Material	Light Color	Lens Color
AlGaInP	Ultra High Yellow	Water Clear

Absolute Maximum Ratings
(Ta=25°C)

Item	Symbol	Maximum	Unit
Power Dissipation	P _D	78	mW
Continuous Forward Current	I _F	30	mA
Peak Forward Current (1/10 Duty Cycle 0.1ms Pulse Width)	I _{FP}	100	mA
Reverse Voltage	V _R	5	V
Derating Linear From 25°C		0.4	mA/°C
Operating Temperature Range	T _{opr}	-30 to +80	°C
Storage Temperature Range	T _{stg}	-40 to +85	°C

Electrical / Optical Characteristics
(Ta=25°C)

Item	Symbol	Condition	Min.	Typ.	Max.	Unit
Forward Voltage	V _F	IF=20mA		2.1	2.6	V
Reverse Current	I _R	VR=5V			10	uA
Peak Emission Wavelength	λ _P	IF=20mA		593		nm
Dominant Wavelength	λ _D	IF=20mA		592		nm
Viewing Angle	2θ _{1/2}	IF=20mA		140		Deg
Luminous Intensity	I _V	IF=20mA	28.5	70.0		mcd

ISSUE	DIMENSION NO :	VERSION :	DATE :
		B	2007/02/01
	APPROVAL :	CHECK :	EDIT :

◆ Packing coding principle

Notice: Bin code: luminous intensity / wavelength / voltage.

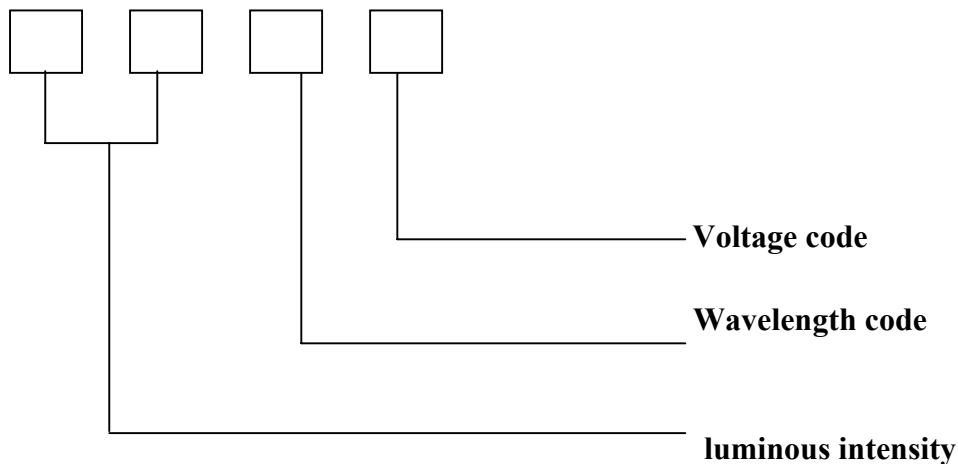

◆ The Luminous Intensity Grade of Ultra High Yellow Chip-LED Products

● Test Condition : @ 20mA

Range, mcd	Bin code
57/72	J2
72/90	K1
90/115	K2
115/145	L1

Dominant Wavelength Grade of Ultra High Yellow Chip-LED Products

● I type @ 20mA

BIN	Range
0	586/588
1	588/590
2	590/592
3	592/594

◆ Forward Voltage Grade of Ultra High Yellow Chip-LED Products

● I type @ 20mA

BIN	Range	BIN	Range
5	1.9/2.0	6	2.0/2.1

◆ **Descriptions :**

- The Chip-LED Taping is much smaller than lead frame type components, thus enable smaller board size, higher packing density, reduced storage space and finally smaller equipment to be obtained.
- Besides, lightweight makes them ideal for miniature application, etc.

◆ **Reliability Test Items And Conditions :**

NO.	Item	Test Conditions	Test Hours / Cycle	Sample Q'ty	Ac / Re
1	Solder Heat	TEMP : 260°C±5°C	5 sec	36 pcs	0 / 1
2	Temperature Cycle	H : +100°C 30min. ∩ 5min. L : -40°C 30min.	50 cycle	36 pcs	0 / 1
3	Thermal Shock	H : +100°C 5min. ∩ 10sec L : -40°C 5min.	50 cycle	36 pcs	0 / 1
4	High Temperature Storage	TEMP : 100°C	1000 hrs	36 pcs	0 / 1
5	Low Temperature Storage	TEMP : -40°C	1000 hrs	36 pcs	0 / 1
6	DC Operating Life	I _F = 20mA	1000 hrs	36 pcs	0 / 1
7	High Temperature / High Humidity	85°C / 90~95%R.H.	1000 hrs	36 pcs	0 / 1

◆ **Reflow Temp. / Time : :**

Please refer to the following figure :

Temp.(°C)		Time(Sec)	
a	25	T0~T1	Max. 3°C/sec
b	150	T1~T2	90~130 sec
c	200	T2~T3	Max. 3°C/sec
d	220	T3~T4	Max. 30~50 sec
e	250		
		T4~T5	Max. -3°C/sec
Blet Speed		70~90 cm/min	

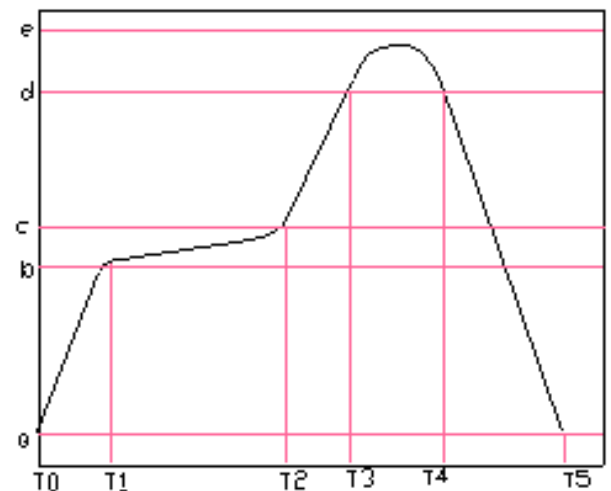

◆ **Precautions For Use :**

- Over - current - proof

Customer must apply resistors for protection, otherwise slight voltage shift will cause big current change (Burn out will happen)

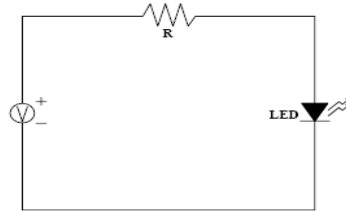

- Storage

1. The operation of temperature and R.H. are : $5^{\circ}\text{C} \sim 30^{\circ}\text{C}$, R.H.60% Max..
2. Once the package is opened, the products should be used within 72 hrs. Otherwise, they should be kept in a dampproof box with desiccating reagent. Considering the tape life, we suggest our customers to use our products within 1 year (from production date) .
3. It's recommended to bake before soldering when the package is unsealed after 72 hrs. The condition is : $80^{\circ}\text{C} \pm 5^{\circ}\text{C}$ for 24hrs.

◆ **Soldering Iron :**

- Temperature at tip of iron : 300°C Max. (25W Max.)
- Soldering time : $5 \pm 1\text{sec}$.

◆ **Wave Soldering Temp. / Time :**

Temp.($^{\circ}\text{C}$)		Time(Sec)	
a	25	T1~T2	60 ± 20
b	130 ± 10	T2~T3	
c	185	T3~T6	
d	250 ± 3	T4~T5	3 ± 2

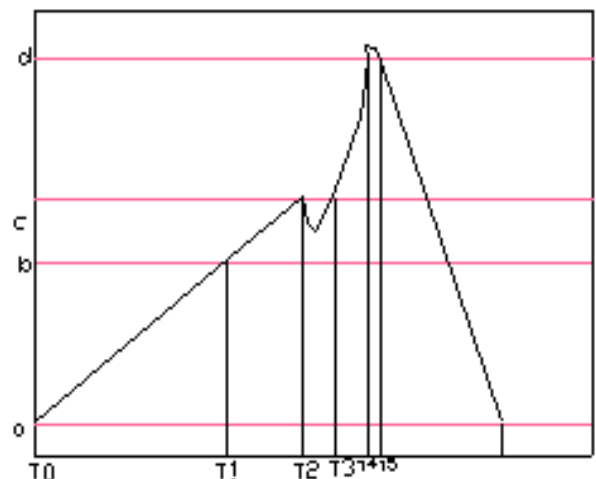

◆ Package Dimensions of Device

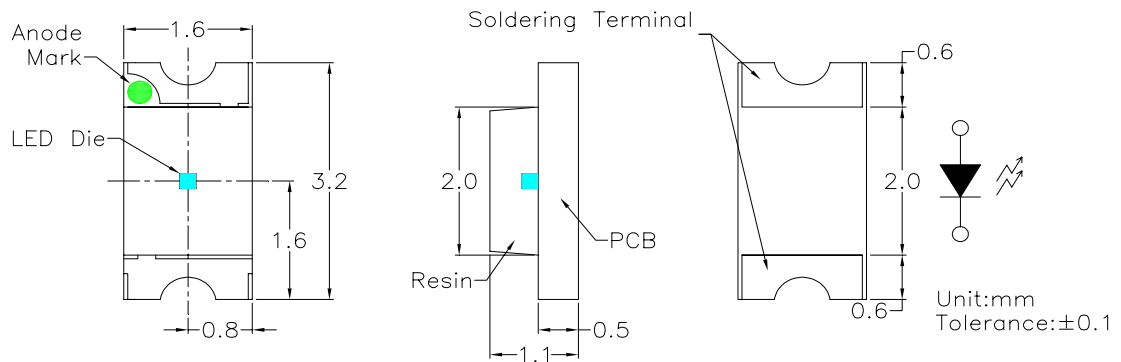

1. Soldering terminal may shift in x, y direction.

◆ Recommended Soldering Pad Dimensions

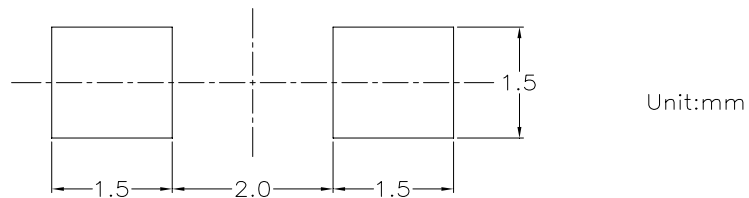

◆ Tape Specification : 3000pcs Per Reel

Packing Size													
Item	W	P1	E	F	D _o	D1	P _o	10P _o	P2	A _o	B _o	K _o	t
Spec.	8.00	4.00	1.75	3.50	1.50	1.00	4.00	40.00	2.00	1.85	3.45	1.27	0.22
Tolerance	±0.20	±0.10	±0.10	±0.05	$\begin{smallmatrix} +0.10 \\ -0.00 \end{smallmatrix}$	±0.05	±0.05	±0.20	±0.05	±0.10	±0.10	±0.10	±0.05

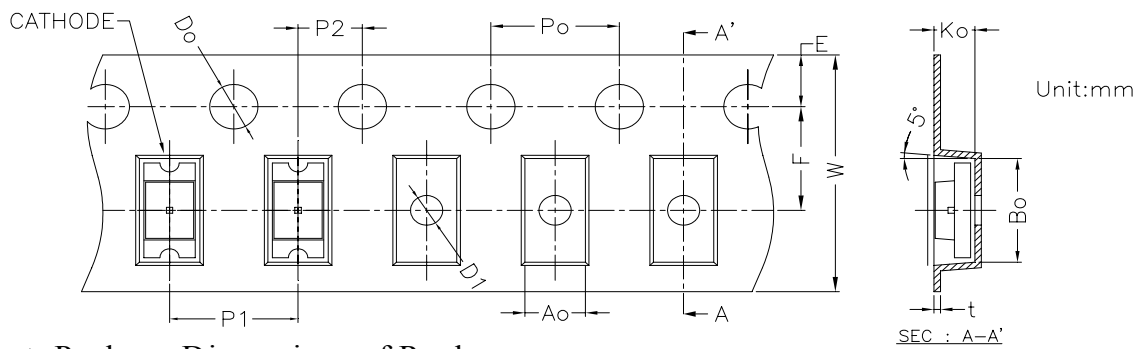

◆ Package Dimensions of Reel :

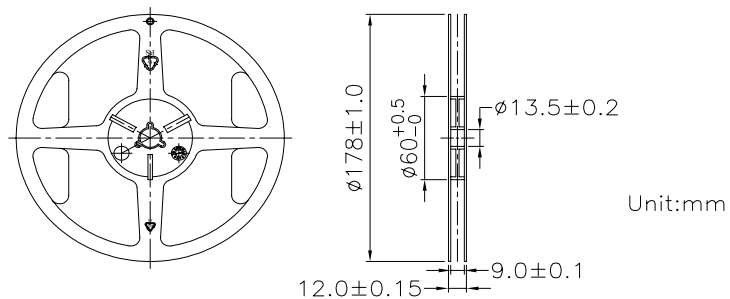

◆ **Typical Electro-Optical Characteristic Curves:**

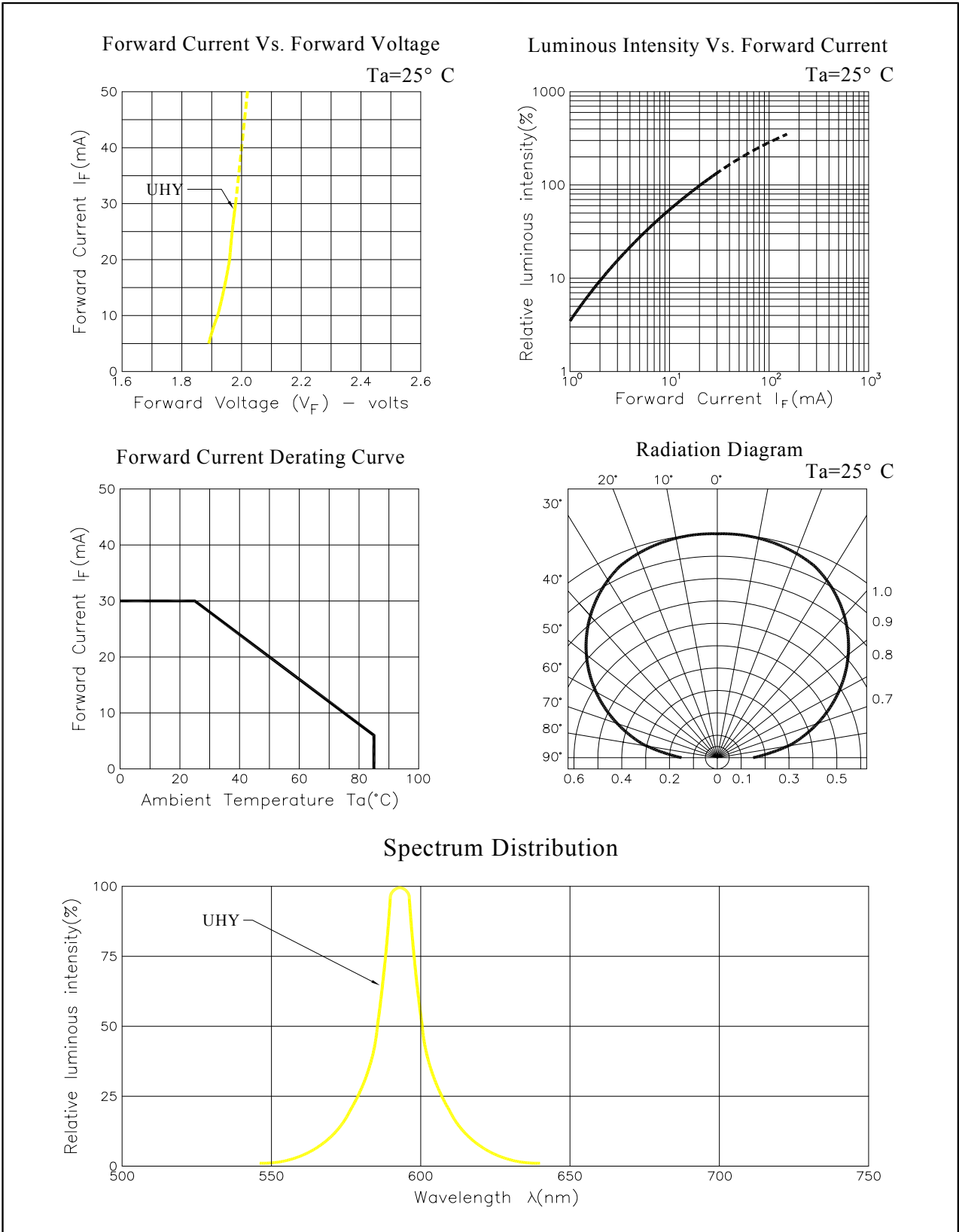

◆ Packing and Shipping Spec.

